

LIMITED WARRANTY

To the consumer, Guardian Technologies LLC warrants this product to be free of defects in materials or workmanship commencing upon the date of the original purchase. Refer to your product carton for the length of warranty and save your original sales receipt to validate start of warranty period.

If this product should become defective within the warranty period, we will repair or replace any defective parts free of charge. The complete machine must be delivered pre-paid to any authorized Guardian Technologies LLC warranty service center. Please include complete information on the problem, day of purchase, copy of original sales receipt and your name, address and telephone number. If you are not near a warranty station, call the factory for assistance in the US and Canada at 1-866-603-5900. Use only genuine Guardian Technologies replacement parts.

The warranty does not include unusual wear, damage resulting from accident, or unreasonable use of the product. This warranty does not cover unauthorized repairs. This warranty gives you specific legal rights and you may also have other rights (other rights may vary from state to state in the U.S.A).

We consider the registration process important to ensuring superior service to our customers, however submitting this card to Guardian Technologies LLC is optional and does not affect your rights to utilize this warranty according to the conditions stated above. If you have any questions or comments about our product call toll free at 1-866-603-5900 or send comments to: Attn: Customer Service, Guardian Technologies LLC, 7700 St. Clair Avenue, Mentor, OH 44060. Warranty registration is also available online at www.guardiantechnologies.com

Guardian Technologies LLC

7700 St. Clair Avenue · Mentor, Ohio 44060
1-866-603-5900 · www.guardiantechnologies.com

©2010 Guardian Technologies LLC

pureguardian™

2-in-1

Upright & Canister

with Silver Clean Technology

USE & CARE INSTRUCTIONS

Replacement Parts:

HEPA Dirt Cup Filter: FLTB

Exhaust Filter: FLTA

Belt Style: BLT1

English Manual.....E-1

French ManualF-1

Spanish ManualS-1

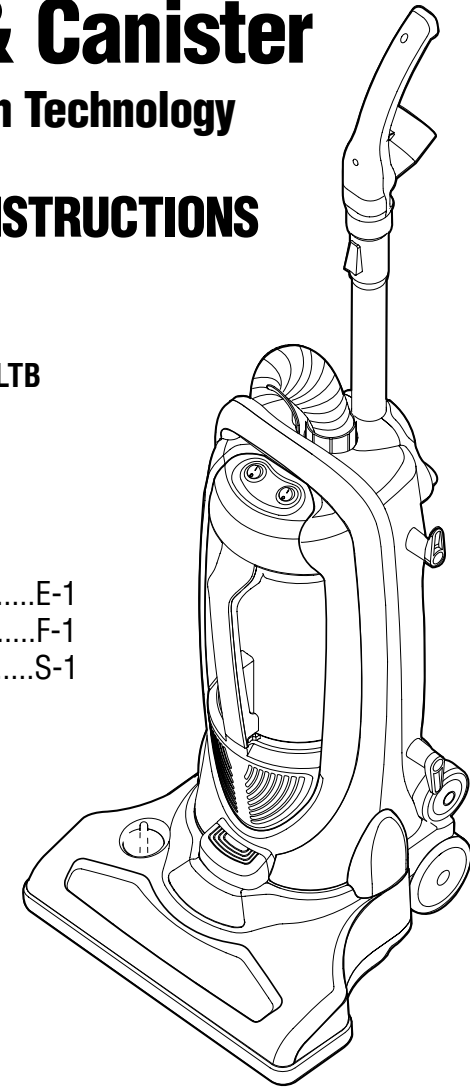

Upright to Canister Model No. GGU300
1 Year Limited Warranty
www.guardiantechnologies.com
1-866-603-5900

REV0411

⚠ WARNING:
Cleaner assembly may include small parts. Small parts can present a choking hazard.

THIS VACUUM CLEANER IS INTENDED FOR HOUSEHOLD USE ONLY

IMPORTANT SAFETY INSTRUCTIONS

When you use an appliance, basic precautions should always be followed. Please read the entire manual before using this appliance.

- **READ ALL INSTRUCTIONS BEFORE USE**
- **ALWAYS FOLLOW SAFETY INSTRUCTIONS**
- **BRING VACUUM TO AN UPRIGHT POSITION IF NOT USING IN CANISTER MODE TO USE THE HOSE AND ATTACHMENTS**
- **DO NOT LEAVE VACUUM CLEANER UNATTENDED WHEN PLUGGED IN**
- **REGULARLY CHECK FILTERS TO CLEAN OR REPLACE**
- **DO NOT OPERATE VACUUM WITHOUT FILTERS**
- **WARNING: DO NOT USE SHARP OBJECTS TO CLEAN OUT THE HOSE SINCE THEY COULD CAUSE DAMAGE**
- **OCCASIONALLY REMOVE BRUSHROLL AND REMOVE DEBRIS FROM END CAPS TO ENSURE BRUSHROLL ROTATES SMOOTHLY**
- **WARNING: THE CORDS, WIRES AND/OR CABLES SUPPLIED WITH THIS VACUUM CONTAIN CHEMICALS, INCLUDING LEAD OR LEAD COMPOUNDS KNOWN TO THE STATE OF CALIFORNIA TO CAUSE CANCER AND BIRTH DEFECTS OR OTHER REPRODUCTIVE HARM. WASH HANDS AFTER USING.**

⚠ WARNING: TO REDUCE THE RISK OF FIRE, ELECTRIC SHOCK OR INJURY:

- Do not leave appliance when plugged in. Unplug vacuum from wall outlet when not in use and before servicing or performing any maintenance on the unit.
- Do not use outdoors or on wet surfaces. Electrical shock could occur.
- Do not use as a toy. Close attention and supervision is necessary when used by or near children.
- Use only as described in this manual. Use only manufacturer's recommended attachments and replacement parts such as filters, belts and headlights.
- Do not use with damaged cord or plug. If vacuum is not working as it should, has been dropped, damaged, left outdoors or dropped in water, return it to the manufacturer for service or call 1-866-603-5900 for more information.
- Do not pull or carry by cord, use cord as a handle, close a door on a cord, vacuum over the cord, pull the cord around sharp corners or edges. Keep cord away from heated surfaces.
- Do not unplug by pulling on cord. To unplug, grasp the plug and not the cord.
- Do not handle plug or vacuum with wet hands.
- Do not put any objects into openings. Do not use vacuum with any openings that are blocked. Keep all openings free of dust, lint, hair and anything that may reduce air flow.
- Keep loose hair, clothing, fingers and all parts of the body away from openings and moving parts.
- Keep animals away from openings and moving parts.
- Do not pick up anything that is burning or smoking, such as cigarettes, matches or hot ashes.
- Do not use without dirt cup container and filters in place. If the vacuum is not working as it should please call customer service at 1-866-603-5900 or visit www.guardiantechnologies.com.
- Turn off all controls before unplugging.
- Use extra care when cleaning on stairs or under furniture.
- Do not use to pick up flammable or combustible liquids such as gasoline or use in areas where they may be present.
- Keep the vacuum cleaner on the floor. Only hand held vacuum cleaners may be set on furniture.
- Do not use an extension cord with this vacuum.
- Store the vacuum indoors. Put the vacuum away after use to prevent tripping accidents.
- Using improper voltage may result in damage to the motor and possible injury to the user. Proper voltage is listed on the data label located on the vacuum cleaner.

SAVE THESE INSTRUCTIONS

⚠ WARNING:

To reduce the risk of electric shock, this vacuum cleaner has a polarized plug (one blade is wider than the other). This plug will fit in a polarized outlet only one way. If the plug does not fit fully in the outlet, reverse the plug. If it still does not fit, contact a qualified electrician to install the proper outlet. Do not change the plug in any way.

PLEASE READ ALL INSTRUCTIONS BEFORE USING THIS APPLIANCE

WARNING! Do not use the Dirt Cup Handle to move the cleaner.

***Thermal Reset Button:** Operates due to over heating, caused by a full dirt cup, clogged filter or blocked pipes. Unplug the cleaner and remove the blocked materials. To operate again, after cooling down the cleaner about 30 minutes, press the thermal reset button.

ModelGGU300	Cord Length32 ft.
Rating120V / 60Hz	Inner Filter.....HEPA Filter
Amperage12 amps	Exhaust FilterMicron Filter
Weight (Net)20.50 lbs	Headlight.....Yes
Dimensions (LxWxH)15" x 14" x 45.25"	BeltYes

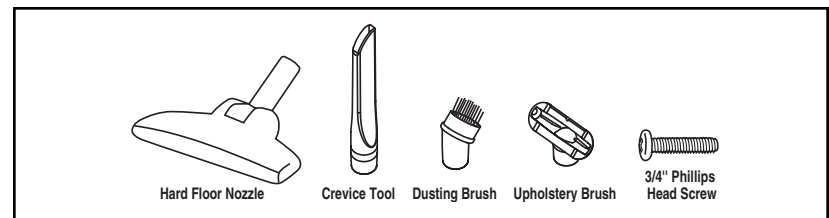
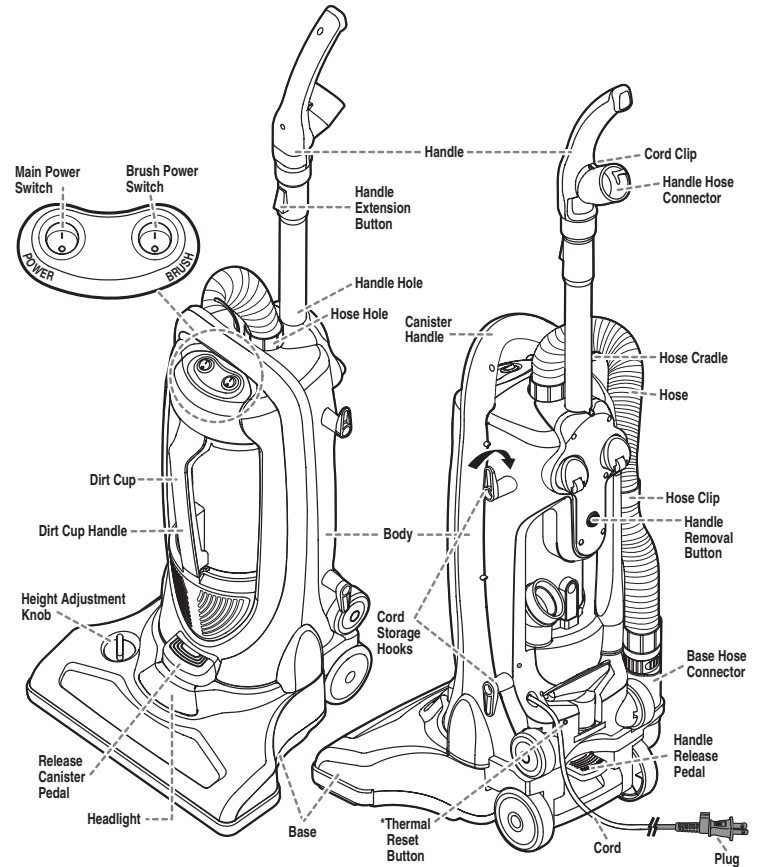

HOSE CRADLE & HOSE ASSEMBLY

- HOSE CRADLE ASSEMBLY
 - Set hose cradle on the top of the cleaner. (Fig. 1)
 - Using a Phillips screwdriver, secure the 3/4-inch screw.
- HOSE ASSEMBLY
 - Insert the body end of hose into the hose hole on the top of the cleaner. (Fig. 2)
 - Line up circular tab on hose cuff with inner groove. (Fig. 2)
 - Connect and twist clockwise to secure proper hose connection. (Fig. 3)
 - Place hose in hose cradle. (Fig. 4)
 - Insert the base end of the hose into the hose inlet on the base of the cleaner. (Fig. 5)

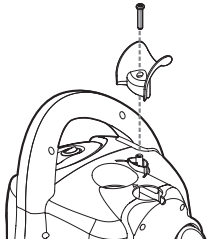

Fig. 1

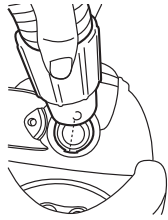

Fig. 2

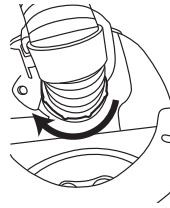

Fig. 3

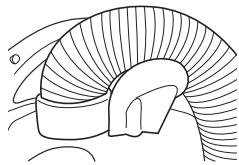

Fig. 4

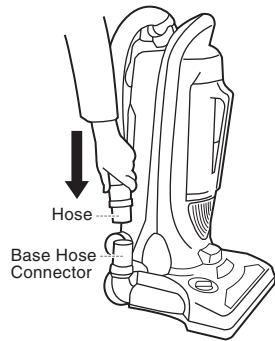

Fig. 5

HANDLE ASSEMBLY

- HANDLE ASSEMBLY
 - Insert handle in the handle hole on the top of the body. (Fig. 6)
- HANDLE DISASSEMBLY
 - Push the handle removal button.
 - Pull handle upward.

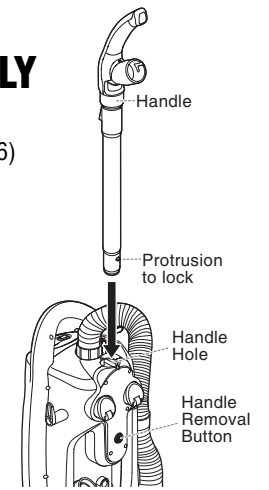

Fig. 6

BASE ASSEMBLY

- BASE ASSEMBLY
 - Set the body on the top of the base. (Fig. 7)
 - Use both sides of the guide feature on the base.
- BASE DISASSEMBLY
 - Push the release canister pedal.
 - Lift up the body.

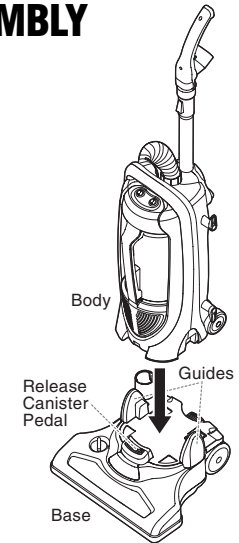
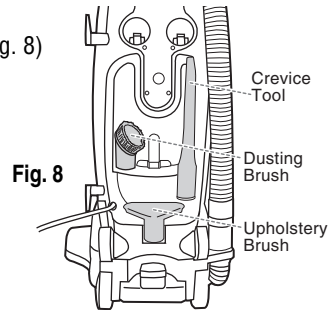

Fig. 7

TOOL ASSEMBLY

- Attach crevice tool, dusting brush and upholstery brush into storage area on the back of the vacuum. (Fig. 8)



UPRIGHT MODE

USING IN UPRIGHT MODE

- Push the handle release pedal. (Fig. 9)
 - Turn main power switch on. Turn brush power switch on.
- Caution:** The headlight and brush does not come on when in the upright position even if the switch is on. You must release the handle for the brushroll to begin spinning. (Fig. 10)

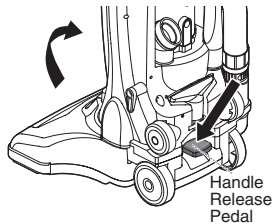

Fig. 9

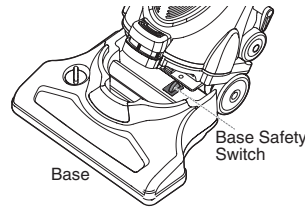

Fig. 10

CONVERTING TO CANISTER MODE

CONVERTING TO CANISTER MODE

- Remove hose from base hose connector. (Fig. 11)
- Step on release canister pedal and pull body upward by canister handle. (Fig. 12)

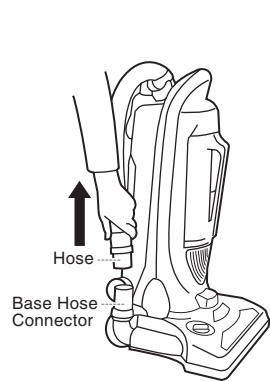

Fig. 11

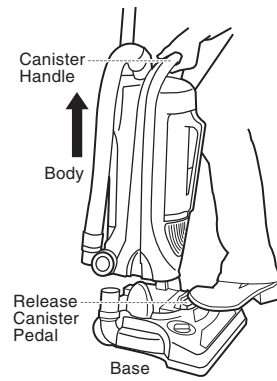

Fig. 12

CONVERTING TO CANISTER MODE (cont.)

- Push handle removal button and pull up on handle to disconnect from body. (Fig. 13)
- Insert hose into handle hose connector and twist clockwise to lock in position. (Fig. 14)
- Push button on wand to extend telescoping wand. (Fig. 14)
- Insert end of handle into hard floor nozzle. (Fig. 15)
- Canister mode. (Fig. 16)

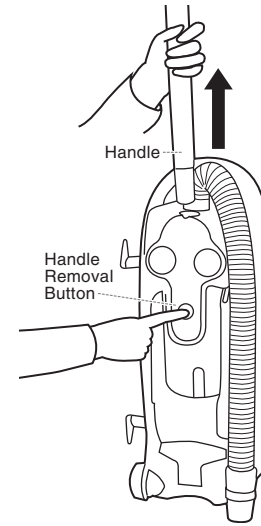

Fig. 13

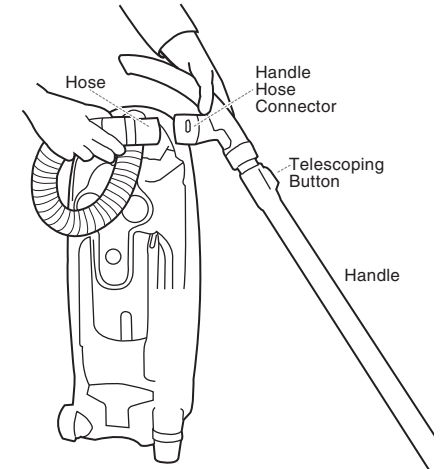

Fig. 14

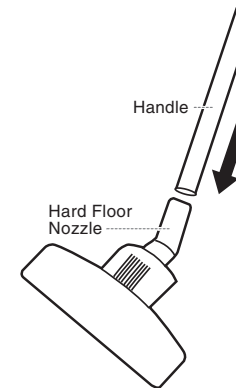

Fig. 15

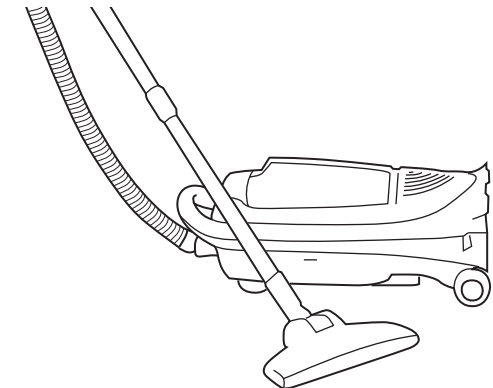
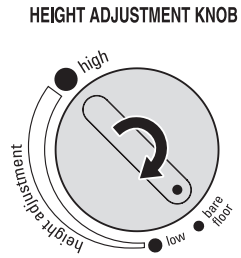

Fig. 16

HEIGHT ADJUSTMENT KNOB

- Rotate the height adjustment knob to the correct carpet height. (Fig. 17)
- To clean bare floor, set this knob to the bare floor position and turn off the brush power switch. (Located on the top of the cleaner, see page 2)

Fig. 17



STORING

- After using the cleaner, store in upright mode.
- Store accessories on the storage clips located on the cleaner body.
- Wrap the cord around the cord storage hooks on the side of the body and hang the plug at the cord clip on the wand. (Fig. 18)

Fig. 18

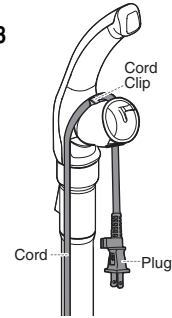

CLEANING & REPLACING FILTER

To optimize the vacuum performance you should clean the filter each time you empty the dirt cup.

- Lift up the dirt cup cover, rotate and remove the inner filter. (Fig. 21)
- Tap the inner filter on a trash bin to remove the dust from the pleats. (Fig. 22)

Note: This inner filter is washable and can be rinsed if you notice a reduction in vacuum performance (suction). To wash, first tap filter to remove excess dirt and dust from the pleats. Rinse filter clean with warm water then allow to completely dry (a minimum of 24 hours) before returning to dirt cup. Use filter: FLT B for inner dirt cup.

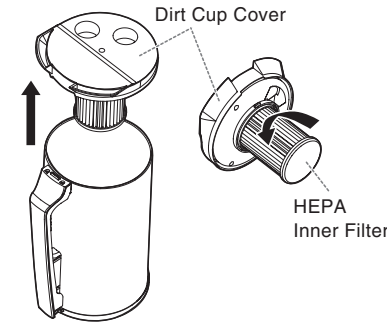

Fig. 21



Fig. 22

CLEANING DIRT CUP

- You will need to empty dirt cup when dust reaches the "FULL" line.
- Turn off the cleaner and unplug from electrical outlet.
- Grasp the dirt cup handle and depress button, pull out the dirt cup from body. (Fig. 19)
- To empty, remove the dirt cup and hold over trash bin. Push the dirt release button and dispose of the dirt. (Fig. 20)

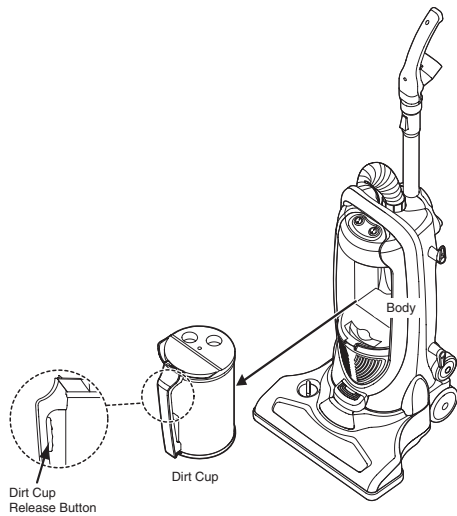

Fig. 19

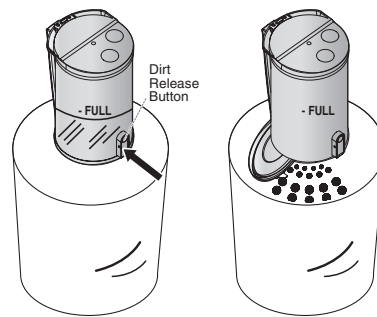

Fig. 20

EXHAUST FILTER CLEANING & REPLACEMENT

- Pull out the exhaust filter. (Fig. 23)
 - Replace the exhaust filter when it becomes dirty. (Fig. 24) Use filter: FLTA for exhaust filter.
- Caution:** This filter is not washable.

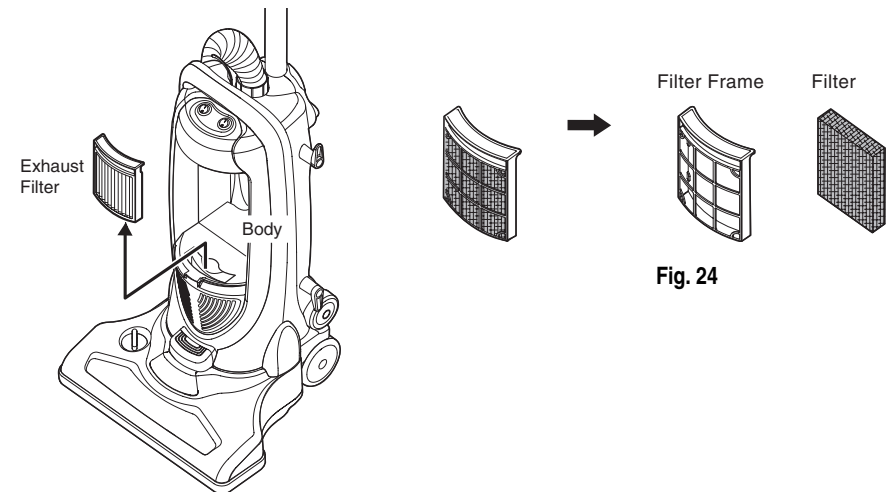

Fig. 23

Fig. 24

Note: Replacement parts can be purchased by calling 1-866-603-5900.

BELT REPLACEMENT

- Warning:** Before replacing the belt, make sure the cleaner is unplugged from electrical outlet.
- Turn off the cleaner and unplug from electrical outlet.
 - Remove the bottom plate of the base by removing the 5 screws using a Phillips screwdriver. (Fig. 25)
 - Set the new belt over motor pulley. (Fig. 26) Use belt: BLT1.
 - Slip the brushroll into the belt and reassemble. (Fig. 27)
 - Replace the bottom plate and secure the 5 screws.

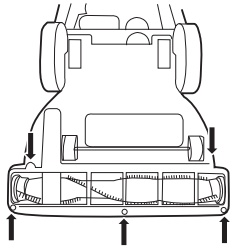

Fig. 25

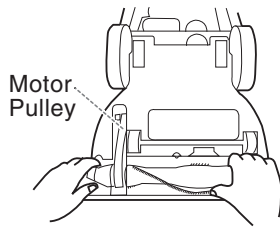

Fig. 26

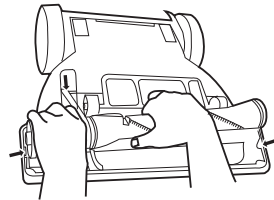

Fig. 27

HEADLIGHT REPLACEMENT

- Turn off the cleaner and unplug from electrical outlet.
- Press the handle release pedal and use the handle to place the body in a flat position.
- Remove the headlight cover by removing the screw with Phillips screwdriver. (Fig. 28)
- Pull the bulb straight out of the socket. (Fig. 29)
- Install the new bulb, model LBU.
- Replace the headlight cover and secure the screw.

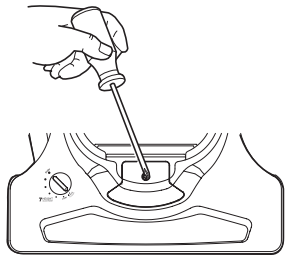

Fig. 28

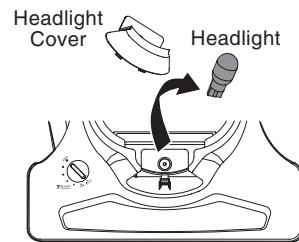

Fig. 29

Note: Replacement parts can be purchased by calling 1-866-603-5900.

TROUBLESHOOTING GUIDE

Please check each item below if you have trouble with your cleaner. Before checking, ensure that the cleaner is unplugged from the power supply.

PROBLEM	PROBLEM	SOLUTION
Cleaner won't run.	<ol style="list-style-type: none"> 1. Power cord not firmly plugged into outlet. 2. Motor protector tripped. 3. Need service. 	<ol style="list-style-type: none"> 1. Plug unit in firmly. 2. Cool down and press the reset button. (See page 3) 3. Take to service center or call 1-866-603-5900
Brushroll won't spin.	<ol style="list-style-type: none"> 1. Cleaner is not in the upright mode. 2. Brush switch is off. 3. Brushroll is jammed. 4. Belt is broken or off motor pulley. 	<ol style="list-style-type: none"> 1. The brush only turns on when the handle is released for vacuuming. The brush does not come on in the upright position even if the switch is on. Depress handle for brushroll to start turning. (See page 5) 2. Make sure the brush switch is in on. 3. Remove it and clean debris, hair, etc. off of brush, then replace. 4. Replace the new belt or correct belt securing. (See page 10)
Cleaner or tool won't pick up dirt.	<ol style="list-style-type: none"> 1. Incorrect height setting. 2. Hose not attached to base. 3. Clogged hose. 4. Dirt cup is full. 5. Inner filter is blocked. 6. Crack or hole in hose. 	<ol style="list-style-type: none"> 1. Rotate setting knob to correct height setting. (See page 7) 2. Grasp hose tube and firmly push onto base. 3. Try to remove clog by squeezing out of hose. 4. Empty dirt cup (See page 8), if washed, after dried well, reinsert it. 5. Clean it or replace new. (See page 9) 6. Take to service center or call 1-866-603-5900.
Cleaner is difficult to push.	<ol style="list-style-type: none"> 1. Incorrect height setting. 2. Brush switch is off. 	<ol style="list-style-type: none"> 1. Rotate height setting knob to correct height setting. (See page 7) 2. Make sure the brush switch is in on.
Visible dust escaping from cleaner.	<ol style="list-style-type: none"> 1. Dirt cup is full. 2. Filter missing or installed incorrectly. 3. Dirt cup installed incorrectly. 	<ol style="list-style-type: none"> 1. Empty dirt cup (See page 8) wash it, after dried well, replace it. 2. Check inner filter & exhaust filter for correct installation. 3. Pull out and re-insert dirt cup correctly.